

SLUG-BUSTER® HYDRAULIC KNOCKOUT KITS

Slug-Buster® Ram and Hand Pump Kits (Inch and Metric)



- Fast, easy and simple to operate
- Compact design for field use on construction sites and maintenance jobs
- Punches 10 times faster than wrench method
- Will also drive 751 Cable Cutter head
- Can be used with most standard round Slug-Buster® and Slug Splitter® SC punches (except 1/2", 9/16", 5/8")
- Can be used with non-round punches (adapter may be required)
- 3-foot hose
- Powerful 11-ton hydraulic ram

CAT NO.	UPC NO.	DESCRIPTION	WEIGHT	
			LBS	KG
7646	15906	Driver with Hand Pump, Draw Studs, Spacer and Plastic Case	20	9.1
7306SB	34360	Driver, Hand Pump, Slug-Buster® Punches, Dies and Draw Studs for 1/2" through 2" Conduit, Adapter, Spacers, Kwik Stepper® Step Bit and Plastic Case	24	10.9
7310SB	34361	Driver, Hand Pump, Slug-Buster® Punches, Dies and Draw Studs for 1/2" through 2" and 2-1/2" through 4" Standard Conduit Size Punches, Dies and Draw Studs, Adapter, Spacers, Kwik Stepper® Step Bit and Plastic Case	54	24.5
7646PG-SB	32799	Metric – Driver, Slug-Buster® Pg Punches, Dies and Draw Studs for 15.2 mm through 60.0 mm, Adapter, Spacers, Kwik Stepper® Step Bit and Plastic Case	24	10.9
38520	38520	Driver, Hand Pump, Slug-Buster® Punches and Draw Studs for 1/2" through 3" and 4" Conduit, Adapter, Spacers, Kwik Stepper® Step Bit and Plastic Case	48	21.8

See Accessories Usage Chart on page XXX

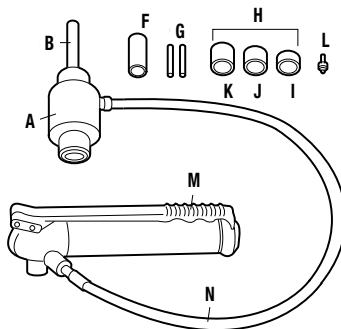

RAM AND HAND PUMP HYDRAULIC DRIVER PARTS IDENTIFICATION

KEY	CAT. NO.	UPC NO.	DESCRIPTION
R	A	746	17091 Ram (includes Item B)
R	B	2113B	10109 Draw Stud-3/4" x 5 3/8"
R	F	1557AA	03170 Punch Sleeve
R	G	20963	20963 Draw Stud-3/8" x 4.8"
R	H	15908	15908 Spacer Group (includes Items I, J and K)
R	I	1924AA	03248 Spacer-Short
R	J	1925AA	03249 Spacer-Medium
R	K	1926AA	06904 Spacer-Long
R	L	34410	34410 Kwik Stepper® Step Bit 1/2"
R	M	767	13284 Hydraulic Hand Pump
R	N	06302	06302 High Pressure Hose-1/4" x 3'

Slug-Buster® Ram and Hand Pump Kits Parts List

CAT NO.	UPC NO.	DESCRIPTION	HOLE SIZE				KIT CAT./UPC NO.				
			CONDUIT & PIPE SIZE	ACTUAL		7646/15906	7306SB/34360	7310SB/34361	7646PGSB/32799	38520	
				Ø INCH	Ø MM						
721-1/2	31756	1/2" Conduit Size Slug-Buster® Punch					✓	✓	✓	✓	
14722	14722	1/2" Conduit Size Die	1/2"	7/8	0.885	22.5		✓	✓	✓	
721-3/4	31757	3/4" Conduit Size Slug-Buster® Punch					✓	✓		✓	
124AV	06972	3/4" Conduit Size Die	3/4"	1-1/8	1.115	28.3		✓	✓	✓	
721-1	31758	1" Conduit Size Slug-Buster® Punch					✓	✓		✓	
126AV	04011	1" Conduit Size Die	1"	1-3/8	1.362	34.6		✓	✓	✓	
721-1-1/4	31759	1-1/4" Conduit Size Slug-Buster® Punch					✓	✓		✓	
128AV	04013	1-1/4" Conduit Size Die	1-1/4"	1-11/16	1.701	43.2		✓	✓	✓	
721-1-1/2	31760	1-1/2" Conduit Size Slug-Buster® Punch					✓	✓		✓	
440AV	04061	1-1/2" Conduit Size Die	1-1/2"	1-15/16	1.951	49.6		✓	✓	✓	
721-2	31761	2" Conduit Size Slug-Buster® Punch					✓	✓		✓	
442AV	04063	2" Conduit Size Die	2"	2-3/8	2.416	61.5		✓	✓	✓	
1429AV	04175	2-1/2" Conduit Size Punch						✓		✓	
1430AV	04177	2-1/2" Conduit Size Die	2-1/2"	2-7/8	2.914	74.0			✓	✓	
1431AV	04180	3" Conduit Size Punch						✓		✓	
1432AV	04183	3" Conduit Size Die	3"	3-1/2	3.539	89.9			✓	✓	
2982AV	04653	3-1/2" Conduit Size Punch						✓			
2981AV	04652	3-1/2" Conduit Size Die	3-1/2"	4	4.044	102.7			✓		
2984AV	04655	4" Conduit Size Punch						✓		✓	
2983AV	04654	4" Conduit Size Die	4"	4-1/2	4.544	115.4			✓	✓	
31969	31969	Pg-9 Slug-Buster® Punch	—	—	0.598	15.2				✓	
32002	32002	Pg-9 Die	—	—						✓	
31970	31970	Pg-11 Slug-Buster® Punch	—	—	0.732	18.6				✓	
32003	32003	Pg-11 Die	—	—						✓	
31971	31971	Pg-13 Slug-Buster® Punch	—	—	0.803	20.4				✓	
32004	32004	Pg-13 Die	—	—						✓	
31973	31973	Pg-21 Slug-Buster® Punch								✓	
32006	32006	Pg-21 Die	3/4"		1.115	28.3				✓	
36284	36284	Slug-Buster® Punch	—							✓	
36279	36279	Die	—	1-7/32	1.210	30.5				✓	
31975	31975	Pg-29 Slug-Buster® Punch	—	—	1.457	37.0				✓	
32008	32008	Pg-29 Die	—	—						✓	
31976	31976	Pg-36 Slug-Buster® Punch	—	—	1.850	47.0				✓	
32009	32009	Pg-36 Die	—	—						✓	
31978	31978	Pg-48 Slug-Buster® Punch	—	—	2.362	60.0				✓	
32011	32011	Pg-48 Die	—	—						✓	
746	17091	Ram (includes following item)					✓	✓	✓	✓	
2113B	10109	Draw Stud-3/4" x 5 3/8"					✓	✓	✓	✓	
1557AA	03170	Punch Sleeve					✓	✓	✓	✓	
20963	20963	Draw stud-3/8" x 4.8"					✓	✓	✓	✓	
15908	15908	Spacer Group (includes 1 ea. of following 3 items)					✓	✓	✓	✓	
1924AA	03248	Spacer-Short					✓	✓	✓	✓	
1925AA	03249	Spacer-Medium					✓	✓	✓	✓	
1926AA	06904	Spacer-Long					✓	✓	✓	✓	
34410	34410	Kwik Stepper® Step Bit 1/2"					✓	✓	✓	✓	
767	13284	Hydraulic Hand Pump					✓	✓	✓	✓	
06302	06302	High Pressure Hose – 1/4" x 3'					✓	✓	✓		
30206	30206	Plastic Case					✓	✓	✓		
05387	05387	Plastic Case							✓	✓	

PUNCHES AND DIES

DRAW STUDS AND MISC.

Slug-Buster® Ram and Foot Pump Hydraulic Driver Kits



- Foot operation frees both hands to position punch
- Punches 10 times faster than wrench method
- Will also drive 751 Cable Cutter head
- Powerful 11-ton hydraulic ram
- Can be used with most standard round, Slug-Buster® and Slug Splitter® SC punch sizes. (except 1/2", 9/16" 5/8")
- Can be used with non-round punches (adapter may be required)

CAT NO.	UPC NO.	DESCRIPTION	WEIGHT	
			LBS	KG
7625	25097	Driver, Foot Pump, Steel Case	37	17
7606SB	07173	Driver, Foot Pump, Slug-Buster® Punches, Dies and Draw Studs for 1/2" through 2" Conduit, Steel Case	42	19
7610SB	07174	Driver, Foot Pump, Slug-Buster® Punches, Dies & Draw Studs for 1/2" through 2" Conduit, Slug-Buster® Punches and 2 1/2" through 4" Conduit Standard Round Punches	60	27

See Accessories Usage Chart on page XXX

Ram and Foot Pump Kits Parts List

CAT NO.	UPC NO.	DESCRIPTION	HOLE SIZE				KIT CAT./UPC NO.			
			CONDUIT & PIPE SIZE	ACTUAL		7625/ 25097	7606SB/ 07173	7610SB/ 07174		
				Ø INCH	Ø MM					
PUNCHES AND DIES	721-1/2	31756	1/2" Conduit Size Slug-Buster® Punch	1/2"	7/8	0.885	22.5		✓	✓
	14722	14722	1/2" Conduit Size Die						✓	✓
	721-3/4	31757	3/4" Conduit Size Slug-Buster® Punch	3/4"	1-1/8	1.115	28.3		✓	✓
	124AV	06972	3/4" Conduit Size Die						✓	✓
	721-1	31758	1" Conduit Size Slug-Buster® Punch	1"	1-3/8	1.362	34.6		✓	✓
	126AV	04011	1" Conduit Size Die						✓	✓
	721-1-1/4	31759	1-1/4" Conduit Size Slug-Buster® Punch	1-1/4"	1-11/16	1.701	43.2		✓	✓
	128AV	04013	1-1/4" Conduit Size Die						✓	✓
	721-1-1/2	31760	1-1/2" Conduit Size Slug-Buster® Punch	1-1/2"	1-15/16	1.951	49.6		✓	✓
	440AV	04061	1-1/2" Conduit Size Die						✓	✓
	721-2	31761	2" Conduit Size Slug-Buster® Punch	2"	2-3/8	2.416	61.5		✓	✓
	442AV	04063	2" Conduit Size Die						✓	✓
	1429AV	04175	2-1/2" Conduit Size Punch	2-1/2"	2-7/8	2.914	74.0			✓
	1430AV	04177	2-1/2" Conduit Size Die							✓
	1431AV	04180	3" Conduit Size Punch	3"	3-1/2	3.539	89.9			✓
	1432AV	04183	3" Conduit Size Die							✓
	2982AV	04653	3-1/2" Conduit Size Punch	3-1/2"	4	4.044	102.7			✓
	2981AV	04652	3-1/2" Conduit Size Die							✓
	2984AV	04655	4" Conduit Size Punch	4"	4-1/2	4.544	115.4			✓
	2983AV	04654	4" Conduit Size Die							✓
DRAW STUDS AND MISC.	746	17091	(A) Ram (includes 1 ea. of items B, C, and D)					✓	✓	✓
	2113B	10109	(B) Draw Stud-3/4" x 5 3/8"					✓	✓	✓
	54167	54167	(C) Female Coupler-1/4"					✓	✓	✓
	54168	54168	(D) Dust Plug					✓	✓	✓
	1557AA	03170	(F) Punch Sleeve					✓	✓	✓
	20963	20963	(G) Draw stud-3/8" x 4.8"					✓	✓	✓
	15908	15908	(H) Spacer Group (includes 1 ea. of items I, J, and K)					✓	✓	✓
	1924AA	03248	(I) Spacer-Short					✓	✓	✓
	1925AA	03249	(J) Spacer-Medium					✓	✓	✓
	1926AA	06904	(K) Spacer-Long					✓	✓	✓
	34410	34410	(L) Kwik Stepper® Step Bit 1/2"					✓	✓	✓
	1725	31353	(S) Hydraulic Foot Pump (includes 1 ea. – 54167 female coupler and 54168 dust plug)					✓	✓	✓
	37729	37729	(T) High Pressure Hose Unit – 1/4" x 10'; filled with hydraulic oil; (includes the following 2 items)					✓	✓	✓
	54169	54169	Couplers					2	2	2
	54170	54170	Dust Caps					2	2	2
23955	23955	(U) Steel case					✓	✓	✓	
25094	25094	Tray					✓	✓	✓	

RAM AND FOOT PUMP HYDRAULIC DRIVER PARTS IDENTIFICATION
(Match letters above to drawing.)

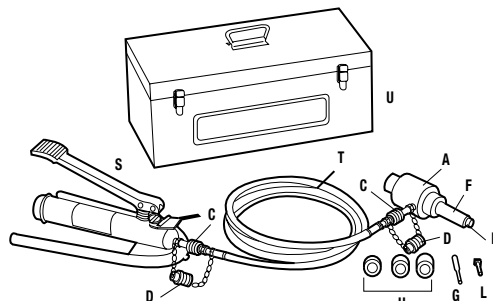

SLUG-BUSTER® KNOCKOUTS

Slug-Buster® Knockout Kit with Ratchet Wrench



7238SB

- 1" Hex Ratchet Wrench allows use with both 3/8" (9.5 mm) and 3/4" (19.1 mm) draw studs
- High-impact, rugged plastic carrying case
- Knockouts Made in the USA



CAPACITY

MILD STEEL WEIGHT

CAT NO.	UPC NO.	DESCRIPTION	MILD STEEL WEIGHT			
			GA	MM	LBS	KG
7238SB	34757	1/2" – 2" Conduit Size Slug-Buster® Knockout Punch Kit	10	3.5	10	4.54

7238SB/34757 SLUG-BUSTER® KNOCKOUT PUNCH KIT INCLUDES

CAT NO.	UPC NO.	DESCRIPTION	ACTUAL HOLE SIZE		
			Ø INCH	Ø INCH	Ø MM
34941	34941	Ratchet wrench – 1" Hex			
721-1/2	31756	1/2" Conduit Size Punch	7/8	.885	22.5
14722	14722	1/2" Conduit Size Die	7/8	.885	22.5
721-3/4	31757	3/4" Conduit Size Punch	1-1/8	1.115	28.3
124AV	06972	3/4" Conduit Size Die	1-1/8	1.115	28.3
721-1	31758	1" Conduit Size Punch	1-3/8	1.362	34.6
126AV	04011	1" Conduit Size Die	1-3/8	1.362	34.6
721-1-1/4	31759	1-1/4" Conduit Size Punch	1-11/16	1.701	43.2
128AV	04013	1-1/4" Conduit Size Die	1-11/16	1.701	43.2
721-1-1/2	31760	1-1/2" Conduit Size Punch	1-15/16	1.951	49.6
440AV	04061	1-1/2" Conduit Size Die	1-15/16	1.951	49.6
721-2	31761	2" Conduit Size Punch	2-3/8	2.416	61.5
442AV	04063	2" Conduit Size Die	2-3/8	2.416	61.5
00042	00042	Ball Bearing Draw Stud with 1" Hex Head–3/8" x 1-5/8"			
304AVBB	04042	Ball Bearing Draw Stud–3/4" x 2-15/16"			
34758	34758	Plastic Case			

Slug-Buster® Manual Knockout Sets

- Assortment of commonly used Slug-Buster® knockout punches, packaged to meet the contractor's needs
- High-impact, rugged plastic carrying case
- Knockouts Made in the USA



7235BB



CAPACITY

MILD STEEL WEIGHT

CAT NO.	UPC NO.	DESCRIPTION	MILD STEEL WEIGHT			
			GA	MM	LBS	KG
7235BB	32013	1/2" - 1-1/4" Conduit Size Manual Slug-Buster® Knockout Punch Kit	10	3.5	2.7	1.2
7237BB	32014	1-1/2" and 2" Conduit Size Manual Slug-Buster® Knockout Punch Kit	10	3.5	5.2	2.4

7235BB/32013 SLUG-BUSTER® KNOCKOUT PUNCH SET INCLUDES

CAT NO.	UPC NO.	DESCRIPTION	HOLE SIZE ACTUAL		
			Ø INCH	Ø MM	
721-1/2	31756	1/2" Conduit Size Punch	7/8	.885	22.5
14722	14722	1/2" Conduit Size Die	7/8	.885	22.5
00042	00042	Draw Stud—3/8" x 1-5/8"	—	—	—
721-3/4	31757	3/4" Conduit Size Punch	—	1.115	28.3
124AV	06972	3/4" Conduit Size Die	—	1.115	28.3
721-1	31758	1" Conduit Size Punch	—	1.362	34.6
126AV	04011	1" Conduit Size Die	—	1.362	34.6
721-1-1/4	31759	1-1/4" Conduit Size Punch	—	1.701	43.2
128AV	04013	1-1/4" Conduit Size Die	—	1.701	43.2
249AVBB	04040	Draw Stud—3/4" x 2-1/8"	—	—	—
31880	31880	Plastic Case	—	—	—

7237BB/32014 SLUG-BUSTER® KNOCKOUT PUNCH SET INCLUDES

CAT NO.	UPC NO.	DESCRIPTION	HOLE SIZE ACTUAL		
			Ø INCH	Ø MM	
721-1-1/2	31760	1-1/2" Conduit Size Punch	—	1.951	49.6
440AV	04061	1-1/2" Conduit Size Die	—	1.951	49.6
721-2	31761	2" Conduit Size Punch	2-3/8	2.416	61.5
442AV	04063	2" Conduit Size Die	2-3/8	2.416	61.5
304AVBB	04042	Draw Stud—3/4" x 2-15/16"	—	—	—
32012	32012	Plastic Case	—	—	—

7237BB



Slug-Buster® Knockout Kit with Ratchet Wrench - Metric

36690



- 1" (25.4 mm) hex ratchet wrench allows use with both 3/8" (9.5 mm) and 3/4" (19.1 mm) draw studs
- 3/8" (9.7 mm) Kwik Stepper® step bit included
- High-impact, rugged plastic carrying case
- Knockouts Made in the USA



CAT NO.	UPC NO.	DESCRIPTION	WEIGHT	
			LBS	KG
36690	36690	Pg-9 through Pg-21 and 30.5 mm Manual Slug-Buster® Metric Knockout Punch Kit	4.7	2.1
36691	36691	Pg-9 through Pg-48 and 30.5 mm Manual Slug-Buster® Metric Knockout Punch Kit	9	4.1
36692	36692	ISO-16 through ISO-40 Manual Slug-Buster® Metric Knockout Punch Kit	5.6	2.5
36693	36693	ISO-16 through ISO-63 Manual Slug-Buster® Metric Knockout Punch Kit	9	4.1

CAT NO.	UPC NO.	DESCRIPTION	HOLE SIZE				KIT CAT./UPC NO.				
			ACTUAL		CAPACITY MILD STEEL		36690	36691	36692	36993	
			IN.	MM	GA	MM					
31969	31969	Pg-9 Slug-Buster® Punch	—	0.598	15.2	14	2.0	✓	✓		
32002	32002	Pg-9 Die	—			14	2.0	✓	✓		
31970	31970	Pg-11 Slug-Buster® Punch	—	0.732	18.6	14	2.0	✓	✓		
32003	32003	Pg-11 Die	—			14	2.0	✓	✓		
31971	31971	Pg-13 Slug-Buster® Punch	—	0.803	20.4	14	2.0	✓	✓	✓	✓
32004	32004	Pg-13 Die	—			14	2.0	✓	✓	✓	✓
721-1/2	31756	Pg-16 Slug-Buster® Punch				10	3.5	✓	✓		
14722	14722	Pg-16 Die	7/8	0.885	22.5	10	3.5	✓	✓		
31973	31973	Pg-21 Slug-Buster® Punch	—	1.115	28.3	14	2.0	✓	✓		
32006	32006	Pg-21 Die	—			14	2.0	✓	✓		
36284	36284	30.5 mm Slug-Buster® Punch				14	2.0	✓	✓		
36279	36279	30.5 mm Die	1-7/32	1.210	30.5	14	2.0	✓	✓		
31975	31975	Pg-29 Slug-Buster® Punch	—	1.457	37.0	10	3.5		✓		
32008	32008	Pg-29 Die	—			10	3.5		✓		
31976	31976	Pg-36 Slug-Buster® Punch	—	1.850	47.0	10	3.5		✓		
32009	32009	Pg-36 Die	—			10	3.5		✓		
31978	31978	Pg-48 Slug-Buster® Punch	—	2.362	60.0	10	3.5		✓		
32011	32011	Pg-48 Die	—			10	3.5		✓		
35163	35163	ISO-16 Slug-Buster® Punch	—	0.638	16.2	14	2.0			✓	✓
35162	35162	ISO-16 Die	—			14	2.0			✓	✓
35165	35165	ISO-25 Slug-Buster® Punch	1	1.000	25.4	14	2.0			✓	✓
35164	35164	ISO-25 Die	—			14	2.0			✓	✓
35169	35169	ISO-32 Slug-Buster® Punch	—	1.280	32.5	10	3.5			✓	✓
35168	35168	ISO-32 Die	—			10	3.5			✓	✓
35158	35158	ISO-40 Slug-Buster® Punch	—	1.595	40.5	10	3.5			✓	✓
35159	35159	ISO-40 Die	—			10	3.5			✓	✓
35160	35160	ISO-50 Slug-Buster® Punch				10	3.5				✓
35161	35161	ISO-50 Die	2	2.000	50.8	10	3.5				✓
35167	35167	ISO-63 Slug-Buster® Punch				10	3.5				✓
35166	35166	ISO-63 Die	2-1/2	2.500	63.5	10	3.5				✓
249AVBB	04040	Draw Stud – 3/4" x 2-1/8"								✓	
304AVBB	04042	Draw Stud – 3/4" x 2-15/16"							✓		✓
36018	36018	Kwik Stepper® Step Bit 9.7mm						✓	✓	✓	✓
34941	34941	Ratchet Wrench – 1" Hex						✓	✓	✓	✓
00042	00042	Ball Bearing Drive Nut with 1" Hex Head, 3/8" x 3"						✓	✓	✓	✓
36685	36685	Plastic Case						✓	✓	✓	✓

PUNCHES AND DIES

DRAW STUDS AND MISC.

Slug-Buster® Knockout Sets



7216



- Packaged in carton for easy insertion into your existing case
- Replacement punch kits for battery-powered, hydraulic and ratchet drivers
- Knockouts Made in the USA

CAT NO.	UPC NO.	DESCRIPTION	WEIGHT	
			LBS	KG
7216	32017	1/2" - 2" Conduit Size Knockout Punch and Die Kit	5.5	2.5
7214E	32398	Pg-9 through 30.5 mm Slug-Buster® Pg Punch Kit	1.3	.6
7215E	32803	ISO-16 through ISO-40 Slug-Buster® ISO Punch Kit	5.1	2.3
35617	35617	ISO-16 through ISO-40 Slug-Buster® ISO Punch Kit	1.6	.7
06892	06892	ISO-16 through ISO-63 Slug-Buster® ISO Punch Kit	5.5	2.5

CAT NO.	UPC NO.	DESCRIPTION	HOLE SIZE		ACTUAL		CAPACITY MILD STEEL		KIT CAT./UPC NO.				
			CONDUIT & PIPE SIZE	IN.	MM	GA	MM	7216	7214E	7215E	35617	06892	
721-1/2	31756	1/2" Conduit Size Punch	1/2"	7/8	0.885	22.5	10	3.5	✓	✓	✓		
14722	14722	1/2" Conduit Size Die					10	3.5	✓	✓	✓		
721-3/4	31757	3/4" Conduit Size Punch	3/4"	—	1.115	28.3	10	3.5	✓				
124AV	06972	3/4" Conduit Size Die					10	3.5	✓				
721-1	31578	1" Conduit Size Punch	1"	—	1.362	34.6	10	3.5	✓			✓	
126AV	04011	1" Conduit Size Die					10	3.5	✓			✓	
721-1-1/4	31759	1-1/4" Conduit Size Punch	1-1/4"	—	1.701	43.2	10	3.5	✓				
128AV	04013	1-1/4" Conduit Size Die					10	3.5	✓				
721-1-1/2	31760	1-1/2" Conduit Size Punch	1-1/2"	—	1.951	49.6	10	3.5	✓				
440AV	04061	1-1/2" Conduit Size Die					10	3.5	✓				
721-2	31761	2" Conduit Size Punch	2"	2-3/8	2.416	61.5	10	3.5	✓				
442AV	04063	2" Conduit Size Die					10	3.5	✓				
31969	31969	Pg-9 Slug-Buster Punch	—	—	0.598	15.2	14	2.0		✓	✓		
32002	32002	Pg-9 Slug-Buster Die	—	—			14	2.0		✓	✓		
31970	31970	Pg-11 Slug-Buster Punch	—	—	0.732	18.6	14	2.0		✓	✓		
32003	32003	Pg-11 Slug-Buster Die	—	—			14	2.0		✓	✓		
31971	31971	Pg-13 Slug-Buster Punch	—	—	0.803	20.4	14	2.0		✓	✓	✓	✓
32004	32004	Pg-13 Slug-Buster Die	—	—			14	2.0		✓	✓	✓	✓
31973	31973	Pg-21 Slug-Buster Punch	—	—	1.115	28.3	14	2.0		✓	✓		
32006	32006	Pg-21 Slug-Buster Die	—	—			14	2.0		✓	✓		
36284	36284	30.5 mm Punch	—	1-7/32	1.210	30.5	14	3.5		✓	✓		
36279	36279	30.5 mm Die	—				14	3.5		✓	✓		
31975	31975	Pg-29 Slug-Buster Punch	—	—	1.457	37.0	10	3.5			✓		
32008	32008	Pg-29 Slug-Buster Die	—	—			10	3.5			✓		
31976	31976	Pg-36 Slug-Buster Punch	—	—	1.850	47.0	10	3.5			✓		
32009	32009	Pg-36 Slug-Buster Die	—	—			10	3.5			✓		
31978	31978	Pg-48 Slug-Buster Punch	—	—	2.362	60.0	10	3.5			✓		
32011	32011	Pg-48 Slug-Buster Die	—	—			10	3.5			✓		
35163	35163	ISO-16 Punch	—	—	0.638	16.2	14	2.0				✓	✓
35162	35162	ISO-16 Die	—	—			14	2.0				✓	✓
35165	35165	ISO-25 Punch	—	1	1.000	25.4	14	2.0				✓	✓
35164	35164	ISO-25 Die	—				14	2.0				✓	✓
35169	35169	ISO-32 Punch	—	—	1.280	32.5	10	3.5				✓	✓
35168	35168	ISO-32 Die	—	—			10	3.5				✓	✓
35158	35158	ISO-40 Punch	—	—	1.595	40.5	10	3.5				✓	✓
35159	35159	ISO-40 Die	—	—			10	3.5				✓	✓
35160	35160	ISO-50 Punch	—	2	2.000	50.8	10	3.5					✓
35161	35161	ISO-50 Die	—				10	3.5					✓
35167	35167	ISO-63 Punch	—	—	2.520	64.0	10	3.5					✓
35166	35166	ISO-63 Die	—	—			10	3.5					✓

SLUG-BUSTER® KNOCKOUTS

Slug-Buster® Knockout Punches 0.492" to 2.520"



- The contractor's choice – worldwide
- Unique punch profile also splits slugs for easier slug removal
- Use with battery-powered, hydraulic, ratchet or manual drivers
- Uses standard Greenlee dies and draw studs
- Slug-Buster® punches available in sizes up thru 2.52" (64.0 mm)
- Knockouts Made in the USA

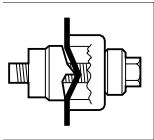

Unique Slug-Buster® punch design creases slug as the punch is drawn into the die.

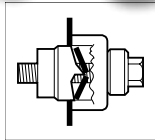

Slug is split in half as punching operation is completed.

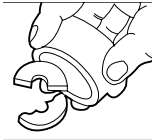

Split slugs fall free from the die and stud.

SPECIFICATIONS

- Capacity** Mild steel up through 10 gauge (3.5 mm).
Application Punch mild steel, aluminum, fiberglass and plastic.
Hole Sizes Conduit Sizes- Hole size is outside diameter of US conduit sizes. i.e 1/2" conduit actually 7/8".
 Pg Sizes-European standard pipe sizes.
 ISO Sizes- International Standards Organization pipe sizes.
Operation Battery, hydraulic, ratchet or manual drivers. When used with ratchet, hydraulic or battery drivers, buy the punch and die only; the draw stud is part of the driver kit.

PUNCH UNIT

◇ Individually packaged in point of purchase clamshell for display opportunities

REPLACEMENT PARTS

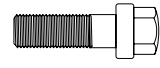
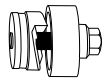

PUNCH UNIT INCLUDES PUNCH, DIE AND DRAW STUD		CONDUIT & PIPE SIZE	HOLE SIZE ACTUAL		CAPACITY MILD STEEL		REPLACEMENT PUNCH		REPLACEMENT DIE		REPLACEMENT MANUAL DRAW STUD		
CAT. NO.	UPC NO.		Ø INCH	Ø MM	GA.	MM	CAT. NO.	UPC NO.	CAT. NO.	UPC NO.	CAT. NO.	UPC NO.	
06727	06727	—	—	0.492	12.5	16	1.5	06728	06728	06729	06729	1675AV	04218
7211EBB-15.2	31989	—	—	0.598	15.2	14	2.0	31969	31969	32002	32002	00042	00042
35177	35177	—	—	0.638	16.2	14	2.0	35163	35163	35162	35162	00042	00042
7211EBB-18.6	31990	—	—	0.732	18.6	14	2.0	31970	31970	32003	32003	00042	00042
12307	12307	—	3/4	—	19.1	14	2.0	12306	12306	12305	12305	00042	00042
7211EBB-20.4	31991	—	—	0.803	20.4	14	2.0	31971	31971	32004	32004	00042	00042
7211BB-1/2	31962	1/2"	7/8	0.885	22.5	10	3.5	721-1/2	31756	14722	14722	00042	00042
◇	◇	1/2"	7/8	0.885	22.5	10	3.5	721-1/2P◇	01980	14722P◇	01992	00042P	06678
12338	12338	—	15/16	—	23.8	14	2.0	12340	12340	12339	12339	00042	00042
35178	35178	—	1	1.000	25.4	14	2.0	35165	35165	35164	35164	00042P	06678
12341	12341	—	1-1/16	—	27	14	2.0	12343	12343	12342	12342	00042	00042
7211BB-3/4	31963	3/4"	—	1.115	28.3	10	3.5	721-3/4	31757	124AV	06972	249AVBB	04040
◇	◇	3/4"	—	1.115	28.3	10	3.5	721-3/4P◇	01981	124AVP◇	01993	249AVBBP◇	01987
7211EBB-28.3	31993	—	—	1.115	28.3	14	2.0	31973	31973	32006	32006	00042	00042
60246	60246	—	1-7/32	1.210	30.5	10	3.5	60237	60237	36278	36278	249AVBB	04040
36508	36508	—	1-7/32	1.210	30.5	14	2.0	36284	36284	36279	36279	00042	00042
12308	12308	—	1-1/4	—	31.8	16	1.5	12309	12309	12310	12310	00042	00042
35179	35179	—	—	1.280	32.5	10	3.5	35169	35169	35168	35168	249AVBB	04040
7211BB-1	31964	1"	—	1.362	34.6	10	3.5	721-1	31758	126AV	04011	249AVBB	04040
◇	◇	1"	—	1.362	34.6	10	3.5	721-1P◇	01982	126AVP◇	01994	249AVBBP◇	01987
7211EBB-37	31995	—	—	1.457	37.0	10	3.5	31975	31975	32008	32008	249AVBB	04040
12313	12313	—	1-1/2	—	38.1	10	3.0	12312	12312	12311	12311	249AVBB	04040
35180	35180	—	—	1.595	40.5	10	3.5	35158	35158	35159	35159	249AVBB	04040
12347	12347	—	1-5/8	—	41.3	10	3.0	12349	12349	12348	12348	249AVBB	04040
7211BB-1-1/4	31965	1-1/4"	—	1.701	43.2	10	3.5	721-1-1/4	31759	128AV	04013	249AVBB	04040
◇	◇	1-1/4"	—	1.701	43.2	10	3.5	721-1-1/4P◇	01983	128AVP◇	01995	249AVBBP◇	01987
12316	12316	—	1-3/4	—	44.5	10	3.0	12315	12315	12314	12314	249AVBB	04040
7211EBB-47	31996	—	—	1.850	47.0	10	3.5	31976	31976	32009	32009	304AVBB	04042
12350	12350	—	1-7/8	—	47.6	10	3.0	12354	12354	12352	12352	304AVBB	04042
7211BB-1-1/2	31966	1-1/2"	—	1.951	49.6	10	3.5	721-1-1/2	31760	440AV	04061	304AVBB	04042
◇	◇	1-1/2"	—	1.951	49.6	10	3.5	721-1-1/2P◇	01984	440AVP◇	01996	304AVBBP◇	01988
35181	35181	—	2	2.000	50.8	10	3.5	35160	35160	35161	35161	304AVBB	04042
36171	36171	—	2-1/8	2.125	54.0	10	3.5	36172	36172	36173	36173	304AVBB	04042
12351	12351	—	2-1/4	—	57.2	10	3.0	12355	12355	12353	12353	304AVBB	04042
7211EBB-60	31998	—	—	2.362	60.0	10	3.5	31978	31978	32011	32011	304AVBB	04042
7211BB-2	31967	2"	2-3/8	2.416	61.5	10	3.5	721-2	31761	442AV	04063	304AVBB	04042
◇	◇	2"	2-3/8	2.416	61.5	10	3.5	721-2P◇	01985	442AVP◇	01997	304AVBBP◇	01988
35182	35182	—	—	2.520	64.0	10	3.5	35167	35167	35166	35166	304AVBB	04042

Slug-Buster SC® (Self-Centering)



- Save time and ensure accuracy! Self-centering punch aligns itself on pilot hole
- No need to draw crosshairs or line up die alignment marks
- Unique punch also splits slugs for easier slug removal
- US Patent No. 6,973,729
- Knockouts Made in the USA



WEIGHT

CAT NO.	UPC NO.	DESCRIPTION	LBS.	KG
10800	10800	1/2" to 2" Conduit Size Slug-Buster SC® Knockout Punch Set	4.8	2.2

10800 SLUG-BUSTER SC® KNOCKOUT KIT INCLUDES

CAT NO.	UPC NO.	DESCRIPTION	CONDUIT SIZE	HOLE SIZE
77P-1/2	11361	1/2" Punch Buster, SC	1/2"	0.885
14722	14722	1/2" Die Rd.	1/2"	0.885
77P-3/4	11362	3/4" Punch Buster, SC	3/4"	1.115
124AV	06972	3/4" Die Rd.	3/4"	1.115
77P-1	11363	1" Punch Buster, SC	1"	1.362
126AV	04011	1" Die Rd.	1"	1.362
77P-1-1/4	11364	1-1/4" Punch Buster, SC	1-1/4"	1.701
128AV	04013	1-1/4" Die Rd.	1-1/4"	1.701
77P-1-1/2	11365	1-1/2" Punch Buster, SC	1-1/2"	1.951
440AV	04061	1-1/2" Die Rd.	1-1/2"	1.951
77P-2	11366	2" Punch Buster, SC	2"	2.416
442AV	04063	2" Die Rd.	2"	2.416



PUNCH UNIT		CONDUIT & PIPE SIZE	HOLE SIZES		PUNCH ONLY		DIE ONLY		STUD ONLY	
CAT NO.	UPC NO.		INCH	MM	CAT NO.	UPC NO.	CAT NO.	UPC NO.	CAT NO.	UPC NO.
77U-1/2	10801	1/2"	.885	22.2	77P-1/2P	11261	14722P	01992	00042	00042
77U-3/4	10802	3/4"	1.115	28.3	77-3/4P	11262	124AVP	01993	249AVBBP	01987
10807	10807	-	1.210	30.5	11357	11357	36278	36278	249AVBB	04040
77U-1	10803	1"	1.362	34.6	77P-1P	11263	126AVP	01994	249AVBBP	01987
77U-1-1/4	10804	1-1/4"	1.701	43.2	77P-1-1/4P	11264	128AVP	01995	249AVBBP	01987
77U-1-1/2	10805	1-1/2"	1.951	49.6	77P-1-1/2P	11265	440AVP	01996	304AVBBP	01988
77U-2	10806	2"	2.416	61.4	77P-2P*	11266	442AVP	01997	304AVBBP	01988