

Powerex, Inc., 200 Hillis Street, Youngwood, Pennsylvania 15697-1800 (412) 925-7272
 Powerex, Europe, S.A. 428 Avenue G. Durand, BP107, 72003 Le Mans, France (43) 41.14.14

Phase Control SCR
 40-80 Amperes (63-125 RMS)
 1600 Volts

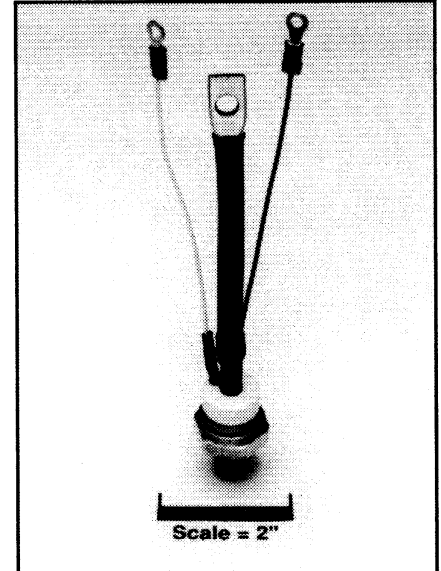
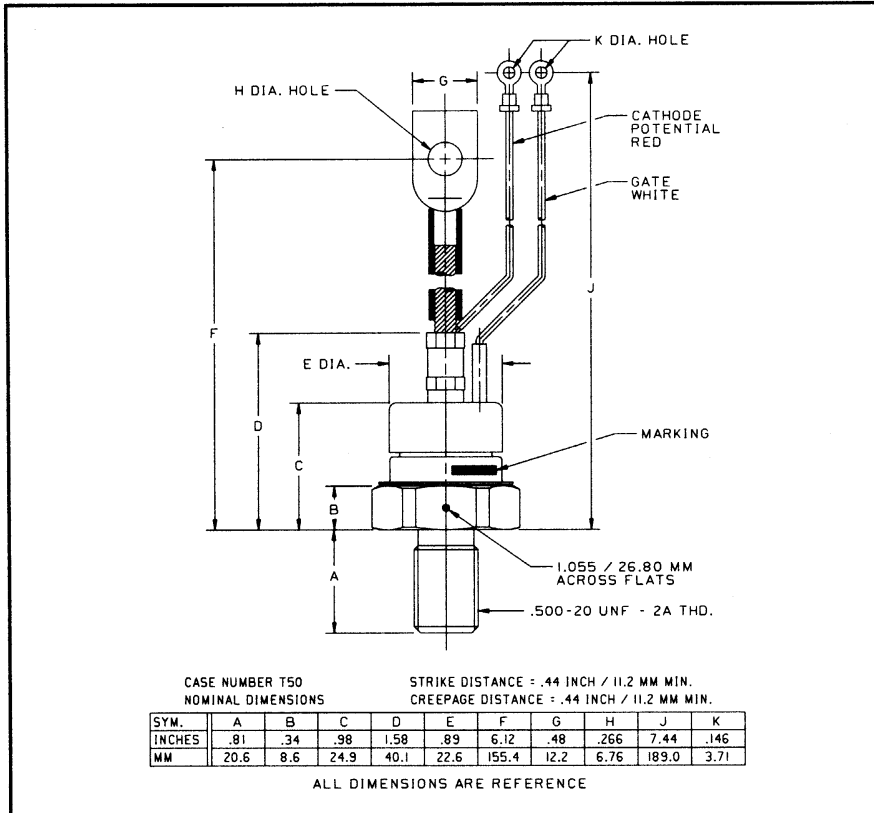

T500 Phase Control SCR
 40-80 Amperes (63-125 RMS),
 1600 Volts

T500, TO-94 (Outline Drawing) Also Available with Flag Lead, TO-83 Package

Ordering Information:

Select the complete part number you desire from the following table:

Type	Voltage *		Current		Turn-off		Gate Current		Leads	
	V _{DRM} & V _{RRM} (Volts)	Code	I _{T(av)} (A)	Code	I _q (μsec)	Code	I _{GT} (mA)	Code	Case	Code
T500	700	07	40	40	100 (Typ.)	0	100	5	TO-94	AQ
	800	08								
	900	09								
	1000	10	80	80					TO-83	AB
	1100	11								
	1200	12								
	1300	13								
	1400	14								
	1500	15								
	1600	16								

Features:

- Center Fired, di/dynamic Gate
- All Diffused Design
- Low V_{TM}
- Compression Bonded Encapsulation
- Low Thermal Impedance
- High Surge Current Capability
- Low Gate Current

Applications:

- Phase control
- Motor Control
- Power Supplies

* For 600V and Below, see T510
 ** For Lower I_{GT} Consult Factory

Example: Type T500 rated at 80A average with V_{DRM} = 1600V, I_{GT} = 150MA, and standard flexible lead, order as:

Type	Voltage	Current	Turn-off	Gate Current	Leads
T 5 0 0	1 6	8 0	0	4	A Q

T50 WITH AB LEAD GROUP

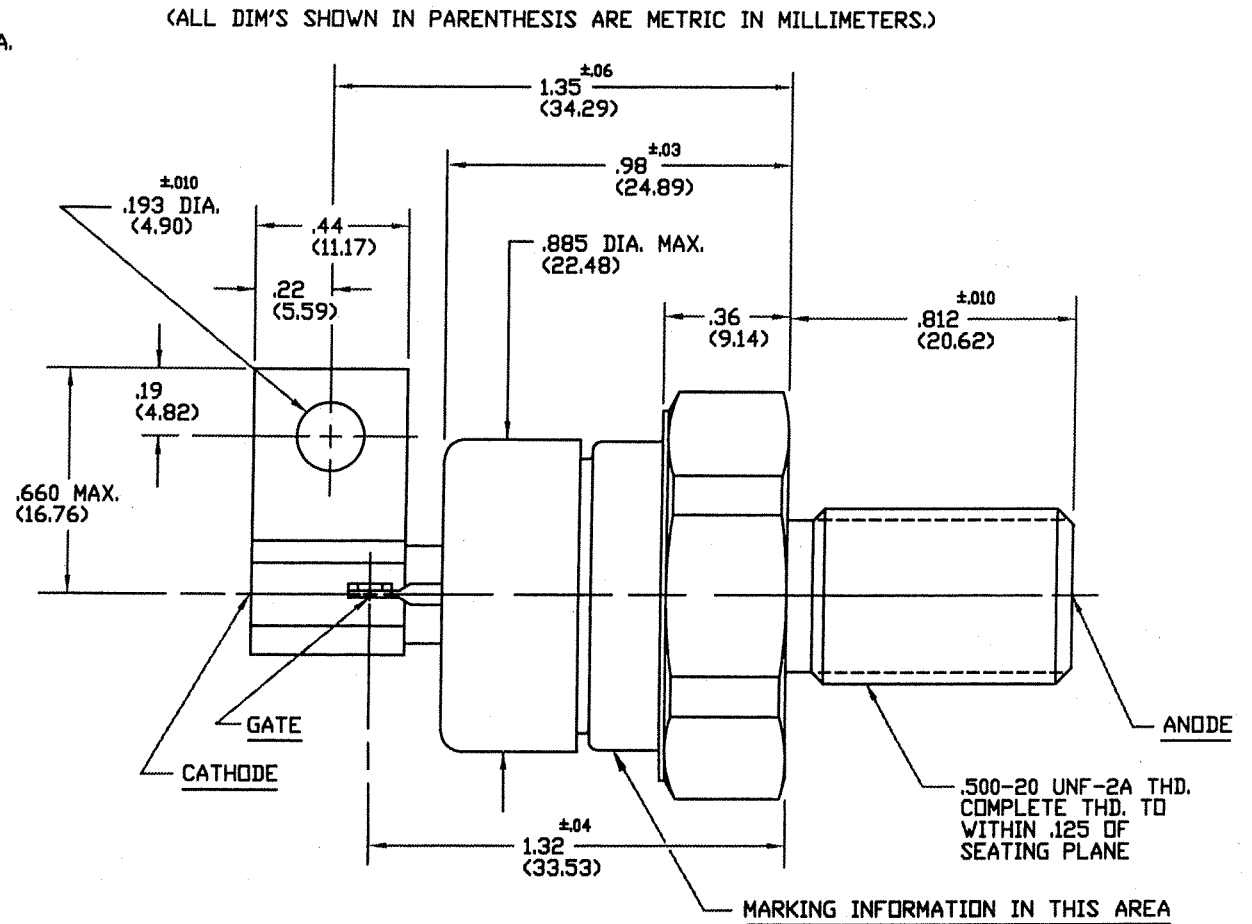
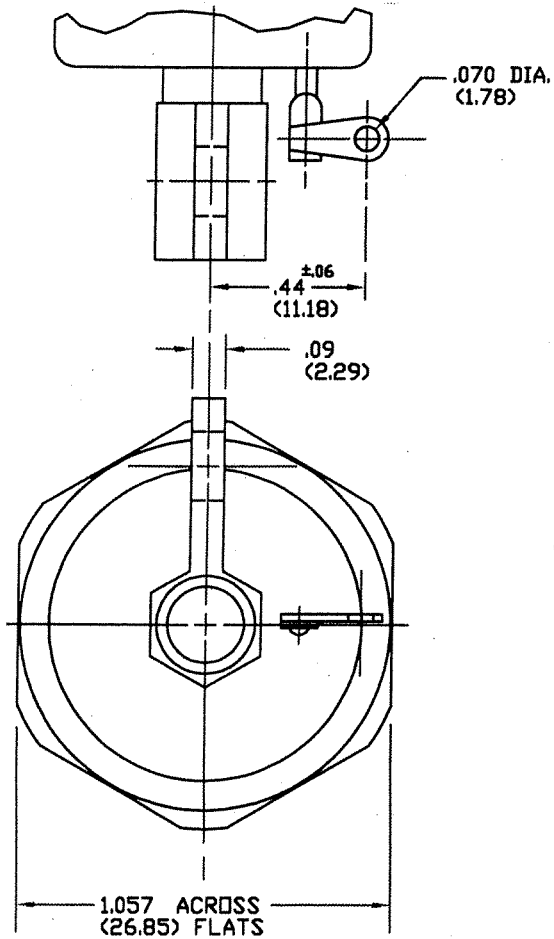

Powerex, Inc., 200 Hillis Street, Youngwood, Pennsylvania 15697-1800 (412) 925-7272
Powerex, Europe, S.A. 428 Avenue G. Durand, BP107, 72003 Le Mans, France (43) 41.14.14

T500 Phase Control SCR
40-80 Amperes (63-125 RMS),
1600 Volts

Absolute Maximum Ratings

Characteristics	Symbol	T500 _ 40	T500 _ 80	Units
RMS Forward Current	$I_{T(rms)}$	63	125	Amperes
Average Forward Current	$I_{T(av)}$	40	80	Amperes
One-half Cycle Surge Current	I_{TSM}	1200	1800	Amperes
3 Cycle Surge Current	I_{TSM}	950	1300	Amperes
10 Cycle Surge Current	I_{TSM}	800	1170	Amperes
Minimum Rate of Rise of On-State Current (Non-repetitive)	di/dt	800	800	Amperes/ μ s
I^2t (for Fusing), ≥ 8.3 milliseconds	I^2t	6000	13500	A^2sec
Peak Gate Power Dissipation	P_{GM}	16	16	Watts
Average Gate Power Dissipation	$P_{G(av)}$	3	3	Watts
Storage Temperature	T_{stg}	-40 to +150	-40 to +150	$^{\circ}C$
Operating Temperature	T_j	-40 to +125	-40 to +125	$^{\circ}C$
Mounting Torque (Lubricated)		130	130	in-lb

T500 Phase Control SCR
 40-80 Amperes (63-125 RMS),
 1600 Volts

Electrical and Thermal Characteristics

Characteristics	Symbol	Test Conditions	T500 _ 40	T500 _ 80	Units
Current - Conducting State Maximums					
Forward Voltage Drop	V_{TM}	$T_j = 25^\circ\text{C}$, $I_{TM} = 500\text{A}$	3.7	2.2	Volts
Voltage - Blocking State Maximums					
Rep. Peak Forward Blocking Voltage (Rated Limit)	V_{DRM}		1600	1600	Volts
Repetitive Peak Reverse Voltage (Rated Limit)	V_{RRM}		1600	1600	Volts
Non-Rep. Trans. Peak Rev. Voltage (Rated Limit)	V_{RSM}	$t_p \leq 5.0 \text{ msec}$	1800	1800	Volts
Forward Leakage Current	I_{DRM}	$T_j = 125^\circ\text{C}$, $V_{DRM} = \text{Rated}$	10	10	mA
Reverse Leakage Current	I_{RRM}	$T_j = 125^\circ\text{C}$, $V_{RRM} = \text{Rated}$	10	10	mA
Switching					
Typical Turn-off Time	t_q	$I_T = 50\text{A}$, $di_R/dt = 5 \text{ A}/\mu\text{sec}$, reapplied $dv/dt = 20\text{V}/\mu\text{sec}$ linear to $0.8 V_{DRM}$, $T_j = 125^\circ\text{C}$	100	100	μsec
Typical Turn-on Time	t_{on}	$I_T = 100\text{A}$, $V_D = 100\text{V}$	4	4	μsec
Minimum Critical dv/dt Exponential to V_{DRM}	dv/dt	$T_j = 125^\circ\text{C}$	300	300	$\text{V}/\mu\text{sec}$
Thermal					
Maximum Resistance, Junction to Case	$R_{\theta(j-c)}$		0.28	0.28	$^\circ\text{C}/\text{Watt}$
Maximum Resistance, Case to Sink (Lubricated)	$R_{\theta(c-s)}$		0.12	0.12	$^\circ\text{C}/\text{Watt}$
Gate - Maximum Parameters					
Gate Current to Trigger	I_{GT}	$T_j = 25^\circ\text{C}$, $V_D = 12\text{V}$	(See Ordering Information)		mA
Gate Voltage to Trigger	V_{GT}	$T_j = 25^\circ\text{C}$, $V_D = 12\text{V}$	3	3	Volts
Non-Triggering Gate Voltage	V_{GDM}	$T_j = 125^\circ\text{C}$, $V_{DRM} = \text{Rated}$	0.15	0.15	Volts
Peak Forward Gate Current	I_{GTM}		4	4	Amperes
Peak Reverse Gate Voltage	V_{GRM}		5	5	Volts

Powerex, Inc., 200 Hillis Street, Youngwood, Pennsylvania 15697-1800 (412) 925-7272
 Powerex, Europe, S.A. 428 Avenue G. Durand, BP107, 72003 Le Mans, France (43) 41.14.14

T500 Phase Control SCR
 40-80 Amperes (63-125 RMS),
 1600 Volts

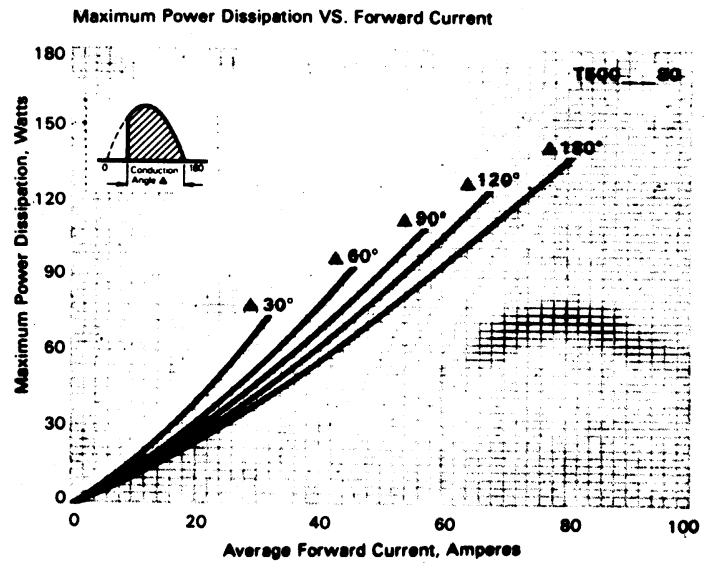
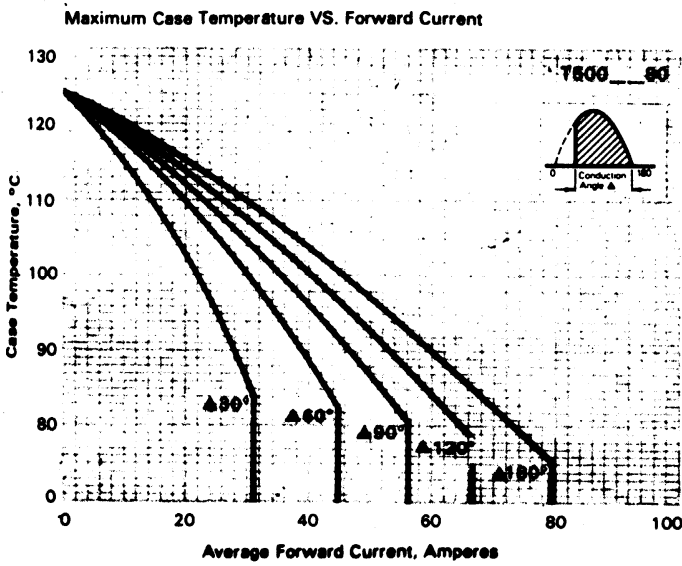
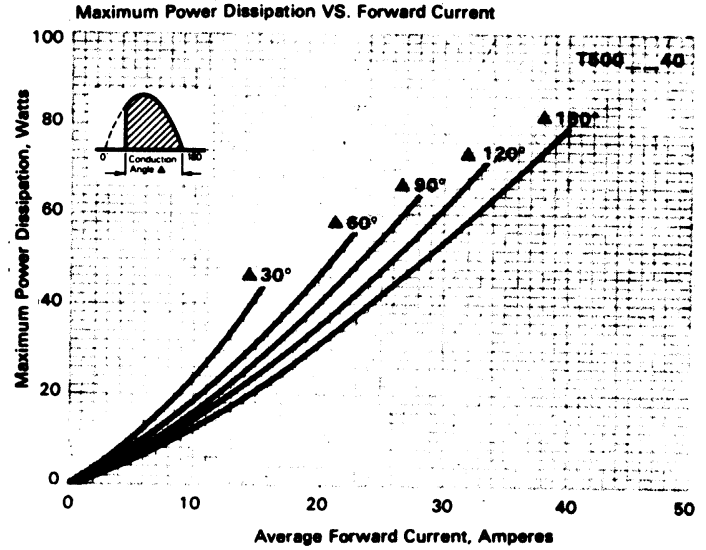
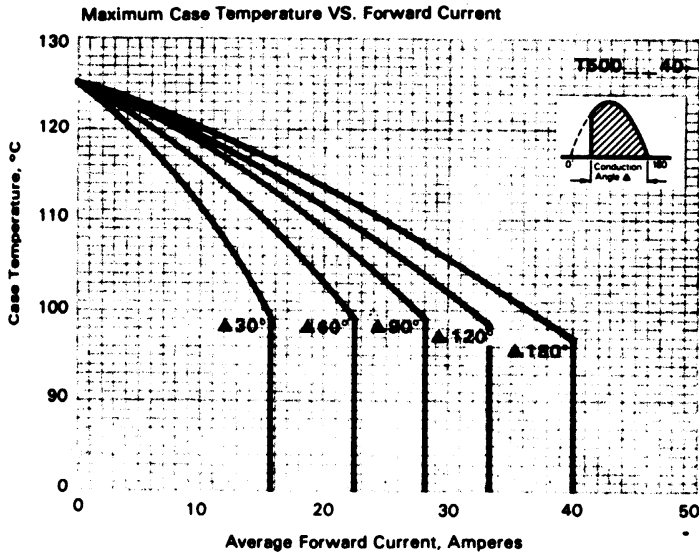

Powerex, Inc., Hillis Street, Youngwood, Pennsylvania 15697 (412) 925-7272
 Powerex, Europe, S.A. 428 Avenue G. Durand, BP107, 72003 Le Mans, France (43) 41.14.14

T500 Phase Control SCR
 40-80 Amperes (63-125 RMS),
 1600 Volts

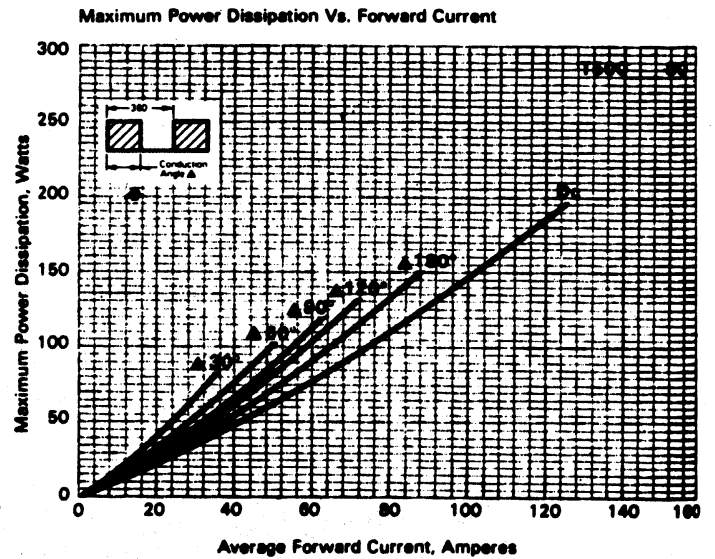
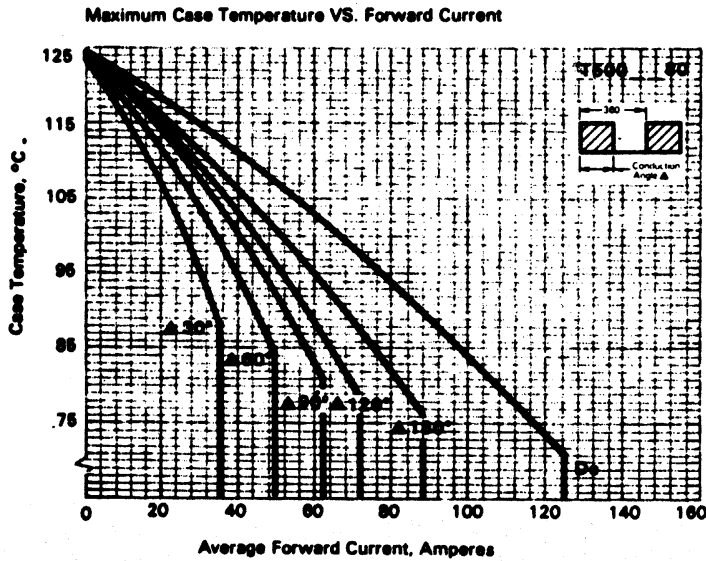
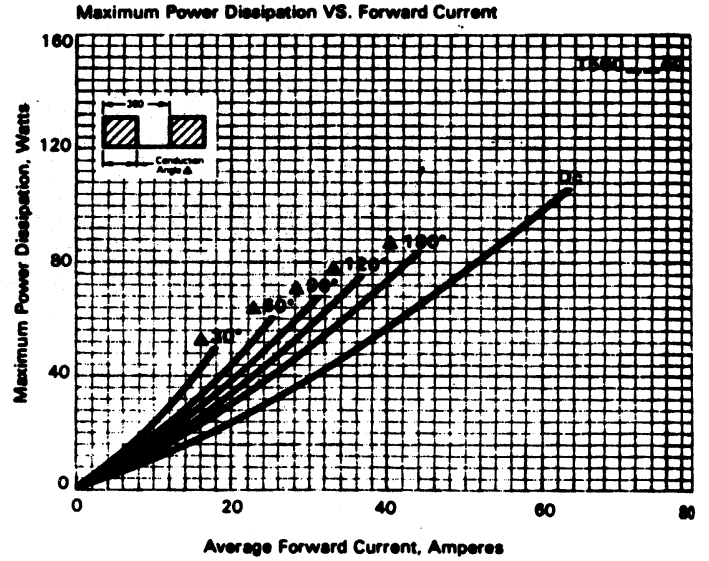
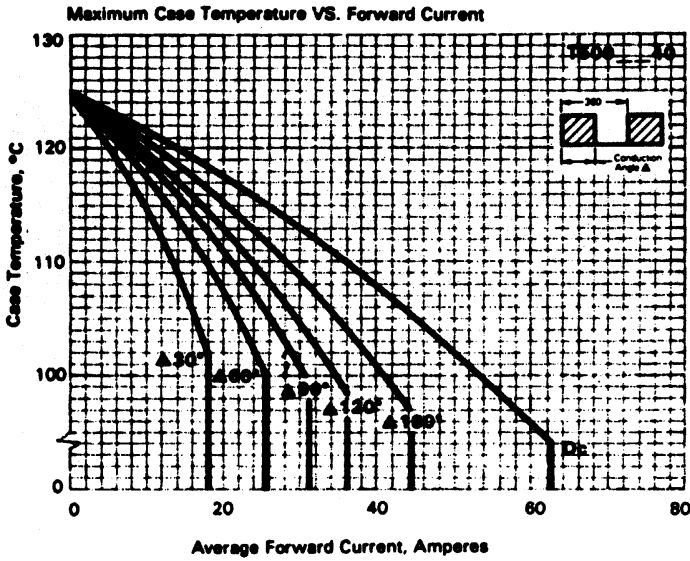

Powerex, Inc., Hillis Street, Youngwood, Pennsylvania 15697 (412) 925-7272
 Powerex, Europe, S.A. 428 Avenue G. Durand, BP107, 72003 Le Mans, France (43) 41.14.14

T500 Phase Control SCR
 40-80 Amperes (63-125 RMS),
 1600 Volts

